

## GRADE 2 MEDIUM DUTY KNOB LOCKSET

Universal Turn Button  
or Push In & Turn Button

Meet ANSI hollow metal and wooden door cutout  
1-3/8" (35MM) - 1-3/4" (45mm) door thickness  
up to 2-1/4" (57mm) optional

Wrought brass or bronze rose  
Ø 75 Spring-clip-on rose standard,  
Ø 65, spin-pin rose available

Wrought brass, bronze or stainless  
steel Ø 54 knob  
Universal, non-handed

Solid brass 1/2" (12.7mm) throw  
deadlatch & spring latch  
Reversible latch for flat & beveled door

UL Label  
UL 3 Hour fire rated

Precision solid brass pin  
tumbler cylinders with brass keys  
Schlage "C" keyway, Weiser &  
SFIC available



### SPECIFICATIONS

- **Certifications:**
  - NSI/BHMA A156.2 Series 4000, Grade 2 strength, operational and 400,000 cycles requirements
  - UL/cUL Listed
  - UL 10C 3 hours fire rating
- **Door Thickness:** 1-3/8" (35mm) to 1-3/4" (45mm)
- **Backset:** 2-3/4" (70mm) standard, 2-3/8" (60mm) optional, 3-3/4" (95mm) and 5" (127mm) available
- **Latch Front:** 1-1/8" (29mm) x 2-1/4" (57mm) standard, 1" (25mm) x 2-1/4" (57mm) optional, square or round corner, beveled, drive-in latch available
- **Latch Bolt:** Solid Brass 1/2" (12.7mm) throw
- **Strike:** ANSI (ASA) curved lip strike standard. SS or Steel material
- **Cylinder & Keys:** Precision solid brass pin tumbler cylinders with nickel silver brass 2 keys. Schlage "C" keyway, Weiser and SFIC available
- **Limited Warranty:** five-year Mechanical
- **Flexibility:**
  - 2 types of rose designs
  - Large selection of functions and finishes available

## TECHNICAL DIMENSIONS

### Knob Design:

Knob (B)

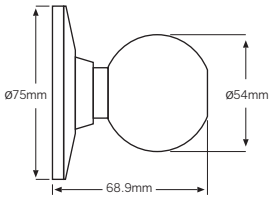

### Rose Design:

Flat Rose (F)

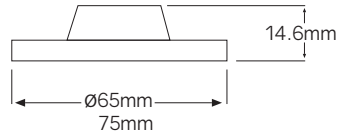

Rose R ( Round)

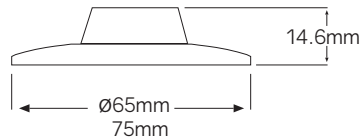

### Door Preparation:

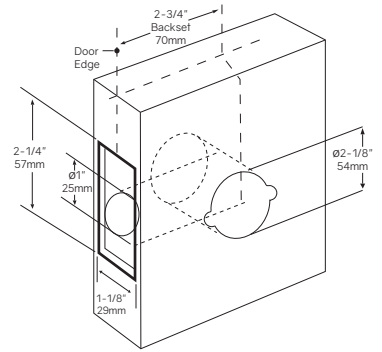

## HOW TO ORDER

K R O M - 2 2 B F 5 3 C 3 2 D W R

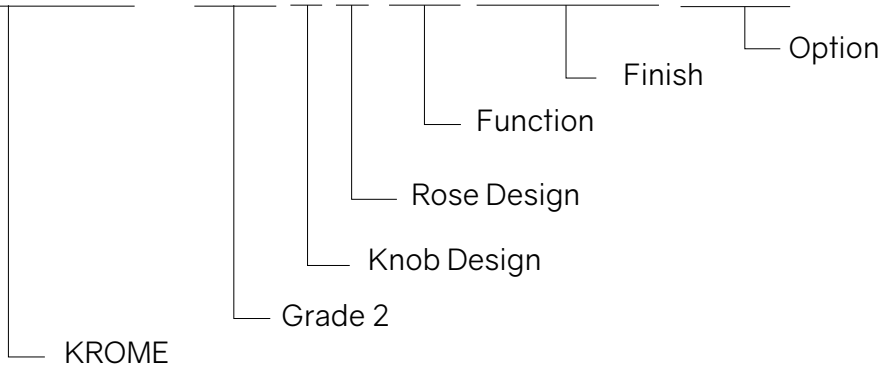

Item Number	Rose	Function	Finish	Option
22B	Flat (F) Round (R)	Passage (10)	Stainles Steel (C32D)	Weiser Keyway (WR)
		Privacy (40)		Bright Brass (C3)
		Entry (53)		
		Classroom (70)		
		Classroom Double (72)		
		Storeroom (80)		
		Storeroom Double (82)		

Note: Default Schlage Keyway

### FUNCTIONS

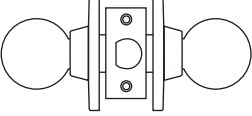
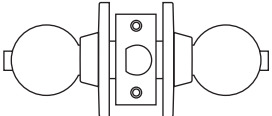
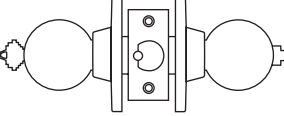
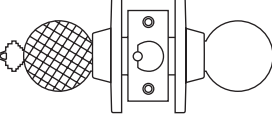
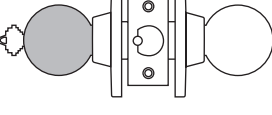
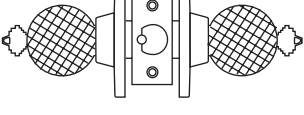
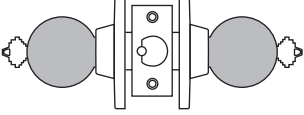
Outside	Inside	Type	ANSI	Function Description
		Passage (10)	HF 75	<ul style="list-style-type: none"> <li>Latchbolt by knob either side</li> <li>Both knobs always free</li> </ul>
		Privacy Bedroom or Bathroom (40)	HF 76	<ul style="list-style-type: none"> <li>Latchbolt by knob either side</li> <li>Outside knob locked by push button</li> <li>Outside knob unlocked by emergency release tool outside by rotating inside knob or by closing door</li> </ul>
		Entrance or Office (53)	HF 81	<ul style="list-style-type: none"> <li>Guard bolt deadlocks latchbolt</li> <li>Latchbolt by either knob unless outside knob is locked by turn button in inside knob</li> <li>Push/ turn button must be released manually</li> <li>Key retracts latchbolt when outside knob is locked</li> </ul>
		Classroom (70)	HF 84	<ul style="list-style-type: none"> <li>Deadlocking latchbolt by knob either side, except when key outside locks outside knob</li> <li>Outside knob unlocked by key outside</li> <li>Inside knob always free</li> </ul>
		Storeroom (80)	HF 86	<ul style="list-style-type: none"> <li>Entrance by key only</li> <li>Outside knob always rigid</li> <li>Inside knob always free</li> </ul>
		Communicating Double Classroom (72)	HF 88	<ul style="list-style-type: none"> <li>Key in either knob locks or unlocks its own knob independently.</li> </ul>
		Communicating Double Storeroom (82)	HF 87	<ul style="list-style-type: none"> <li>Both knobs always rigid</li> <li>Deadlocking latchbolt by key either side</li> </ul>